

USER MANUAL and PARTS LIST

MULTI-MOVER 3XL 30TO

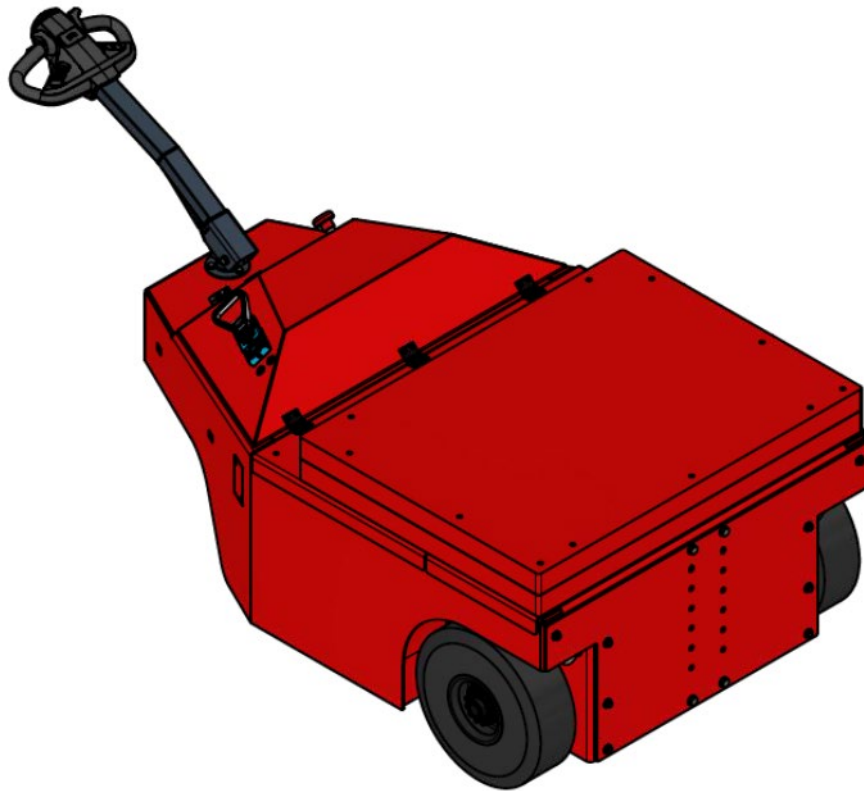

Tighten all wheel bolts to 120nm after the first 2 hours of driving.

Transport

- * Only use stable loading surfaces with sufficient loading capacity (see section 2.2).
- * Secure the MULTI-MOVER 3XL 30TO against tilting or sliding.
- * It is prohibited to;
 - get under the MULTI-MOVER 3XL 30TO while lifting
 - remain within the tilting range of the MULTI-MOVER 3XL 30TO during unloading

Contents

Chapter 1	INTRODUCTION / WARRANTY / DEFINITIONS / SAFETY SYMBOLS	3
Chapter 2	TECHNICAL DESCRIPTION	4
2.1	Designation, identification and description	4
2.2	Technical information and dimensions	4
2.3	Packaging, loading / unloading, towing, recycling	5
Chapter 3	SAFETY REGULATIONS	6
Chapter 4	PREPARATION	9
4.1	Application	9
4.2	Operator	10
4.3	Responsibility operator	10
4.4	Inspection prior to putting into operation	10
Chapter 5	USE	11
5.1	General	11
5.2	Regulations for use	12
5.3	Operation	13
5.4	Batteries	15
5.5	Coupling trailer(s)	18
Chapter 6	MAINTENANCE	18
6.1	Inspection	19
6.2	Lubrication and maintenance diagram	19
6.3	Cleaning	19
6.4	Taking out of operation	19
6.5	Annual maintenance	19
Chapter 7	ENVIRONMENT	20
Chapter 8	FAILURES	21
Chapter 9	PARTS	21
Chapter 10	DECLARATION OF CONFORMITY	22
Appendix	I Electrical circuit diagram	
Appendix	II User manual battery charger	
Appendix	III Part List Ex View	

Multi-Mover Europe B.V.

www.multi-mover.eu

T +31 24 744 00 70 F +31 24 890 17 90

T +49 2842 909 2005

1 INTRODUCTION / WARRANTY / DEFINITIONS / SAFETY SYMBOLS

You have made the right decision, by purchasing the Multi-Mover 3XL 30TO. You are now in the possession of an excellent tool that has been constructed and produced with the greatest care. You will profit the most from this investment, if you carefully observe the safety, user and maintenance instructions provided in this user manual.

The user manual should be made available to the user of the Multi-Mover 3XL 30TO and must be present at the Multi-Mover 3XL 30TO when it is being used. The user manual must have been read by anyone working with/at the Multi-Mover XXL 10 TO, and the instructions must be observed.

Warranty

Multi-Mover Europe BV will not assume responsibility for the goods it produced and the services it supplied. Warranty can only be claimed if the client has made an immediate complaint and Multi-Mover Europe BV has been given the opportunity to investigate the complaints and correct possible faults. Multi-Mover Europe BV provides a warranty on its products in relation to materials and construction defects. In case of defects as described above, Multi-Mover Europe BV shall undertake to provide the parts manufactured by them for free, within the period of one year after delivery.

To occasions, different warranty conditions apply. Multi-Mover Europe BV will not be liable for damage and indirect damage as a result of natural disasters, operational errors, lack of skilful maintenance and any other use than described below.

The liability of Multi-Mover Europe BV will also terminate as soon as you or a third party performs work, such as adaptations or extensions, to the machine, without our written permission.

The warranty conditions only apply if a defect, after investigation by the manufacturer, is recognized as such.

At Multi-Mover Europe BV we continuously try to improve our products and service. That is why we reserve the right to change the specifications stated in this user manual at any required moment and without prior notice.

Definitions

In this user manual we use the following definitions;

Operator:	The person who drives, controls and supervises the operation of the Multi-Mover 3XL 30TO and is able to start and stop it, etc. It is the company's responsibility to make sure that the operator is sufficiently trained.
Dangerous areas:	The area surrounding the Multi-Mover 3XL 30TO where people may get injured.
Maintenance mechanic:	The person who is completely familiar with the Multi-Mover 3XL 30TO, is able to adjust the safety devices and to maintain the Multi-Mover 3XL 30TO. The maintenance mechanic is familiar with the functionality's, safety standards and was trained to maintain the Multi-Mover 3XL 30TO. It is the company's responsibility to make sure that maintenance staff has been sufficiently educated and trained.

Optional

Safety symbols

On various places on the Multi-Mover 3XL 30TO you will find standardised safety symbol stickers as displayed to the right.

The upper part warns against a general or particular hazard.

The lower part indicates what type of hazard is being warned against and will explain what you must do.



2 TECHNICAL DESCRIPTION

2.1 Designation, identification and description

Designation : MULTI-MOVER 3XL 30TO

Identification : type plate on the encasing

Description : vehicle on two drive wheels and a swivel wheel

: suitable as towing device, optionally provided with an upward and downward moving coupling point, for instance, in order to couple the pole of a trailer and possibly to lift it.

: drive while walking, by using the driving switches on the steering handle

Accessories

The following parts are delivered separately with the vehicle:

The vehicle's operation manual

Battery Charger and Manual

Manuals for possible options

2.2 Technical information and dimensions Multi-Mover 3XL 30TO standard version

PUSH AND PULL FORCE 10,000 KG

- Weight 2,500-3,200 kg
- Length 191 cm
- Width 125 cm
- Height 85 / 150 cm

- Engine power 10kW 48VDA, maintenance-free
- 8 x 6-volt 240 Ah battery pack, maintenance-free, AGM lead acid
- Charger 48 volts, 30A, high frequency
- Push and Pull 30,000 kg or 15,500 newton horizontal traction
- Solid-rubber tyres Continental SC20, 10-inch rims
- Ergonomic tiller head with emergency stop, belly button
- Speed reduction system in case excessive cornering speed
- Steerable Tiller head with power steering
- 2 Potentiometer, of which 1 continuous setting and 2 pre-sets to 5 km/h
- Inching forwards and backwards
- Emergency stop switch on the housing
- Emergency stop on Tiller head (vertical position)

- Battery, hour and error display
- Lock with 3 keys
- Horn
- Minimum speed is 0.1 km/h
- Coupling thread at various heights for couplings
- Rockinger 30 ton semi-automatic bolt coupling #
- Work area: 6 km
- Operating time: 3-4 work days

Always supplied with 8 batteries (in the drive box), external charger and 30-ton coupling. There are many options to choose from.

2.3 Packaging, loading / unloading, towing, recycling

Packaging

The Multi-Mover 3XL 30TO is secured with straps on support beams on a pallet or in a case , surrounded by a protective cardboard box.

Removing the packaging

Remove the clamping strips at the wheels.

Avoid injury and damage as a result of incorrect placement of the lift truck's lift forks.

Loading and unloading

If the Multi-Mover 3XL 30TO has to be moved by means of a lift truck, the lift forks must be placed at the heaviest part at the rear of the Multi-Mover 3XL 30TO, between the 2 large wheels.

Towing

Caution! Avoid serious damage to the drive, the Multi-Mover 3XL 30TO may only be moved or towed if the Electric magnetic brake inside the engine box on the engine has been released.

Recycling of the packaging

Save the packaging for possible future transportations.

If you want to remove the packaging, you must observe the local and national regulations concerning plastic waste processing.

3 SAFETY REGULATIONS.

Only use the Multi-Mover 3XL 30TO for the purpose for which it was designed.

The symbols displayed below have been attached to your Multi-Mover 3XL 30TO.
Get to know these symbols and make sure you know what they mean.

3.1

Caution! Hazard of serious injury.

Carefully read the user manual of the Multi-Mover 3XL 30TO, so you will know exactly how to use the switches before you start driving it.



3.2

Caution! Hazard of injury during maintenance work.

Switch off the ignition and remove the ignition key, disconnect the charging plug and press the emergency stop.

Consult the user manual.

You will prevent dangerous situations that might arise if the Multi-Mover 3XL 30TO starts to move unexpectedly.

Also consider the possibility that the vehicle is switched on by a third party, a coincidence or misunderstanding that could occur if the ignition key is still in the ignition.



3.3

Caution! Hazard of serious injury due to getting jammed or a collision.

Make sure that nobody can get jammed, also not at the trailer(s) that are being towed.

Particularly when riding along on the Multi-Mover 3XL 30TO or the trailer(s) to be towed, there will be a risk of getting jammed or having a collision.

3.4

Caution! Hazard of serious injury on slopes due to tipping over.

The Multi-Mover 3XL 30TO was constructed for driving on flat, dry, metalled and sufficiently supportive terrain.

The maximum slope angle that can be driven on, strongly depends on;

- the weight to be towed
- the driving style of the operator
- driving circumstances, and the strength of the terrain.

Caution! Hazard of serious injury due to unwanted movements on slopes as result of insufficient traction force and brake force of the Multi-Mover 3XL 30TO.

Never drive onto a slope at an angle or crosswise.

Only ever drive on and off a slope at a right angle.

The Multi-Mover 3XL 30TO with trailer(s) may also tip over if the bends are taken at a speed that is too high.



3.5

As the trailers may limit the operator's view and because the Multi-Mover 3XL 30TO and trailer(s) may swerve out, there will be a risk of collision, therefore:

Caution! Hazard of (serious) injury due to collisions.

Make sure that bystanders remain at least 10 metres outside of the driving area of the Multi-Mover 3XL 30TO and trailer(s).



3.6

Caution! Hazard of (serious) injury due to getting jammed or as a result of falling under the Multi-Mover 3XL 30TO or trailer(s).

Passengers may “never” drive along on the Multi-Mover 3XL 30TO or the trailers.

3.7

Caution! Hazard of serious injury.

Adapt your speed to the circumstances while driving.

Always make sure you have the Multi-Mover 3XL 30TO under control.

-Reduce speed on uneven floors/terrain and in sharp bends.

-Be particularly careful when manoeuvring and reversing.

3.8

Caution! Hazard of injury due to getting jammed when connecting and disconnecting the trailer(s).

Keep your hands and fingers away from the coupling, hydraulic system (option) or pole eye.



3.9

Caution! Hazard of serious injury.

Before you start driving, make sure the walking/driving area is free and flat.

Avoid getting jammed between the Multi-Mover 3XL 30TO and obstacles.

Prevent tripping and getting jammed under the Multi-Mover 3XL 30TO and/or trailer.

Make sure the driving area and your shoes are free of dirt, in order to prevent accidents due to slipping.

3.10

Caution! Hazard of serious injury due to overloading the Multi-Mover 3XL 30TO.

The load behind the Multi-Mover 3XL 30TO may not be more than indicated at section 2.2 technical data.

Make sure the trailer(s) has/have been loaded evenly and safely.

3.11

Caution!

Wear clothing that allows you to move freely and does not hinder your view on the Multi-Mover 3XL 30TO plus trailer(s). Observe your company's safety regulations.

3.12

Caution! Hazard of injury. In case of an unusual noise;

Stop the Multi-Mover 3XL 30TO immediately.

Check the electric system and the drive for damage.

Check the wheels and tyres for tension, damage and wear.

3.13

Caution! Avoid injury.

Regularly check whether there are any loose bolts and nuts.

Also see chapter 6 (Maintenance).

3.14

Caution! Avoid injury by checking the Multi-Mover 3XL 30TO for damage or bends on a daily basis.

Pay particular attention to the tow eye with tow pen or coupling point and locking.

3.15

Caution! Hazard of injury.

Make sure the Multi-Mover 3XL 30TO is properly and safely supported when performing cleaning or maintenance work "under" the Multi-Mover 3XL 30TO.

3.16

Caution! Hazard while charging the battery.

Make sure there is assistance within the range of your voice and also make sure there is sufficient soap and water nearby if you need to perform work near the battery.

Avoid short-circuit (sparks), make sure you do not make an electrical connection between the battery poles. Make sure no metal objects can fall on the battery, as this could cause a short-circuit or a spark and an explosion.

Remove personal objects such as rings, bracelets, necklaces and watches if you are performing work near the battery. A short-circuit, for example, could melt a ring, resulting in serious burns.

3.17

Caution! Hazard of injury due to overheating of the electrical connection of the battery charger.

Pay particular attention to cable diameter, earth and fuses.

3.18

Caution!

Serious injury can be received or caused if the Multi-Mover 3XL 30TO is operated by;

- persons younger than 16 years of age
- persons who do not have any training and driving experience with the Multi-Mover 3XL 30TO
- persons of whom it can be expected that they are not (sufficiently) aware of the dangers of the Multi-Mover 3XL 30TO, temporary personnel for instance.

The MULTI-MOVER 3XL 30TO may only be operated after the operator has thoroughly studied the user manual and after the owner of the Multi-Mover 3XL 30TO has provided a full training / instruction concerning the operation and the safety regulations.

3.19

Caution! Hazard of serious injury.

Serious injury may be received or caused if the safety instructions are not provided to other operators.

3.20

Caution! You are NOT allowed to use the public road with the Multi-Mover 3XL 30TO.

3.21

Caution!

Hazard of injury if the safety symbols are not clearly visible (any more).

Immediately replace damaged stickers.

3.22

Caution! Hazard of injury.

- maintenance and repair work may only be performed by a maintenance mechanic who is recognized by Multi-Mover Europe BV.
- only original Multi-Mover Europe BV or CE certified parts may be used in the Multi-Mover 3XL 30TO.

3.23

As the operator you will determine the limits for "safe driving / working" with the Multi-Mover 3XL 30TO.

Do not take any risks.

Be particularly careful in case of obstacles or uneven terrain.

4 PREPARATION

4.1 Application

The Multi-Mover 3XL 30TO was developed for;

- moving trailers, trolleys, wagons, trucks or other vehicles with or without goods, machine picking, etc.
- driving over flat, dry, metalled or un-metalled terrain (e.g. warehouse, concrete, asphalt etc.)

The Multi-Mover 3XL 30TO is **not** suitable for transporting trailers with people.

The Multi-Mover 3XL 30TO is **not** suitable for moving;

- goods containing toxic substances
- goods containing explosive substances
- goods containing hazardous substances
- combustible substances
- other liquids and hazardous substances than stated above

If you want to move the substances mentioned above we offer an ATEX Casing

The Multi-Mover 3XL 30TO does **not** have permission to be driven on public roads without safety options. It is not a vehicle according to the Law.

Only use the Multi-Mover 3XL 30TO for the purpose for which it was designed.
For other applications, the CE mark does not apply.

The electric components and wiring have been made splash-proof. IP54 Multi-Mover 3XL 30TO should be covered if used in a spray plant or car-wash etc. and should also be stored in a dry location. Although Multi-Mover has been designed for use out of doors and in poor weather conditions, it should not be driven in to water.

Only the following "original" "Multi-Mover Europe BV" parts and accessories may be used for the Multi-Mover 3XL 30TO. Multi-Mover Europe BV is excluded from any liability for damages or consequential damages that are caused by "original" parts that have not been supplied by us.

4.2 Operator

Only persons who have had a thorough (internal) theoretical and practical training for driving the Multi-Mover 3XL 30TO, are allowed to drive with the Multi-Mover 3XL 30TO.
The training programme should cover:

- the application possibilities and the limitations
- the control and operating components
- the safety regulations
- daily and periodical maintenance

The operator must be fully familiar with the content of this user manual.

People could receive or cause serious injury, if the Multi-Mover 3XL 30TO is operated by;

- **unauthorized persons**
- **persons younger than 18 years of age**
- **persons of whom it may be expected that they are not (sufficiently) aware of the dangers of the Multi-Mover 3XL 30TO**

4.3 Responsibility of the operator

Operators must strictly observe the safety regulations, which are included in chapter 3, and the same applies to the other rules of conduct elsewhere in this user manual.

4.4 Inspection prior to putting into operation

In addition to good maintenance, the operator of the Multi-Mover 3XL 30TO must pay attention to the following aspects after each work period.

- check whether there is any damage on the outside of the vehicle
- check the tow eye and tow pin or coupling point for bends or damage
- check whether the batteries are sufficiently charged
- drive forward and backward and check the operation of the brake.

- check, while driving slowly, the full manoeuvrability of the Multi-Mover 3XL 30TO
- check the jam safety on the steering handle by pressing the safety switch (2, fig. 9), the Multi-Mover 3XL 30TO should not start in that case.

If you establish a fault, or if you have any doubts concerning the operation of the Multi-Mover 3XL 30TO you must immediately report this to your supervisor or the maintenance personnel.

5 USE

5.1 General

Always keep an eye on bystanders, avoid collisions.

Keep as far to the right as possible and maintain distance. (in the UK and IE left)

Never overtake another vehicle driving in the same direction at crossings, in small passages or on other dangerous places

- Make sure you keep a good view on the path that you are driving, keep an eye on traffic and people and observe the safety regulations.
- Caution! Hazard of serious injury due to unwanted movements on slopes as result of insufficient traction force and brake force of the Multi-Mover 3XL 30TO.
- **Never drive onto a slope or another obstacle at an angle or crosswise.**
- **Only ever drive on and off a slope at a right angle.**
- **The Multi-Mover 3XL 30TO may also tip over if the bends are taken at a speed that is too high.** Maximum slope angle, with / without load 4% / 20 %

Passengers may **not** be taken along with the Multi-Mover 3XL 30TO and towed vehicle.

When leaving the Multi-Mover 3XL 30TO, **always** remove the ignition keys.

(Let someone) check whether your Multi-Mover 3XL 30TO is suitable (approved) for driving in your environment, you could think of an environment with fire hazard or explosion hazard.

While driving, the generation of sparks may prevent switching on / off.

The traction batteries are filled with hazardous electrolyte that could cause serious burns. However, the batteries are fully sealed and do not have to be refilled with distilled water.

In case of injury to people or damage to buildings, immediately contact your supervisor.

Never park at fire lanes, fire-extinguishers and stairwells.

5.2 Regulations for use

Observe the traffic regulations;

- in a normal traffic situation you will keep to the right
- maintain a safe distance, depending on your speed, you will maintain a safe speed so you are able to maintain in complete control of your vehicle and trailer(s)

Make sure you keep a good overview of the area where you are driving and observe the safety regulations.

At crossings and locations where there is no good view, lower your speed and give a warning signal. Drive slowly on narrow lanes.

Avoid bends if necessary and be careful on small hills, thresholds, etc. Reduce speed in case of sharp bends.

The Multi-Mover 3XL 30TO may only be driven at speeds that allow you to stop in time, e.g. if an obstacle is standing in or entering the driving area. Accelerating, stopping, steering, making turns should always be performed quietly, so that the stability of the trailers to be towed is not endangered. Your conduct while driving must be polite and safe.

Always be careful when the vehicle is driving on a limited slope or on slippery grounds.

Placement in /on a lift

Never manoeuvre the Multi-Mover 3XL 30TO in/on a lift without permission; drive it slowly, place the vehicle correctly in the centre of this space, switch off the vehicle with the ignition key. Make sure there are no people on the lift when the vehicle is driven onto it.

Only transport safe and stable loads.

Make sure the weight of the load to be moved lies within the capacity of the Multi-Mover 3XL 30TO. The maximum traction force is stated on the type plate.

Prior to putting the Multi-Mover 3XL into operation, you must acquaint yourself with its possibilities. Read the instructions in advance and check the function of the control units with the ignition key in the OFF position. See fig. 2

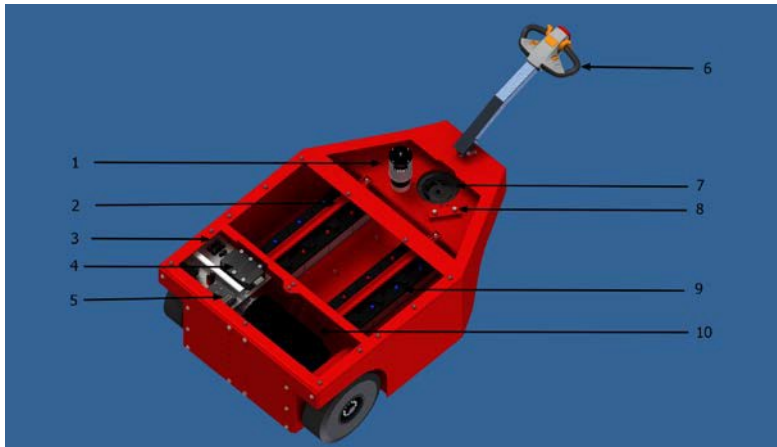

5.3 Operation (see photo, fig. 1)

- 1 Power steering motor
- 2 Batterie bar
- 3 Fuse Box
- 4 Control box unit 1 motor
- 5 Control box unit 2 power steering
- 6 Steering handle (Tiller head)
- 7 Power steering gear unit
- 8 Set box
- 9 Batteries 8x
- 10 Motor with reduction gear unit

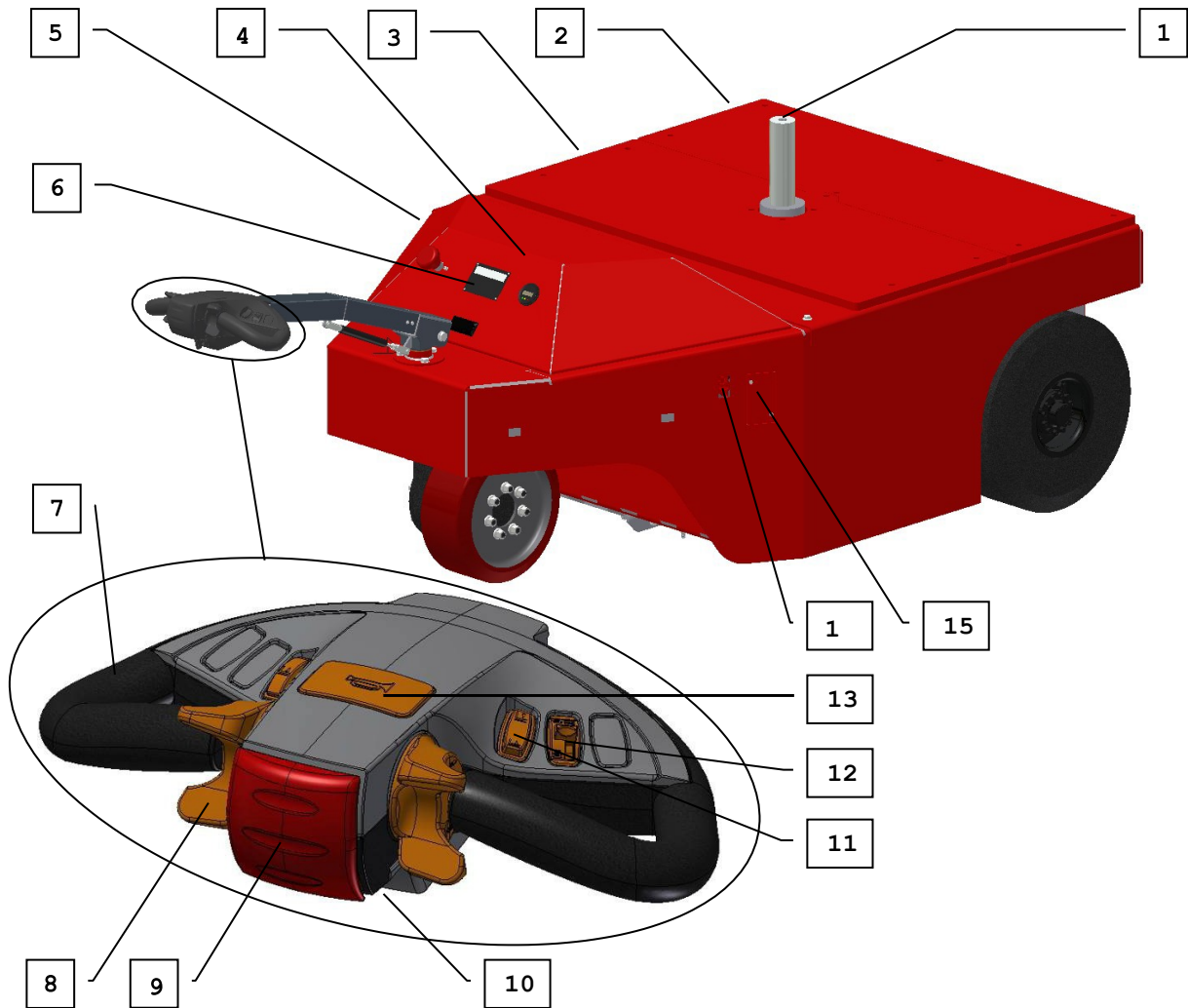

Figure 2

- | | |
|-------------------------------------|-------------------------------|
| 1 Coupling point (# optional) | 11 Potentiometer slow/fast |
| 2 Inching forwards and backwards2.8 | 12 Potentiometer continuously |
| 3 Counter weight | 13 Horn |
| 4 Motor controller indicator | 14 Plug for charger |
| 5 Emergency Stop on Engine Case | 15 Main Fuse |
| 6 Plate with serial number | |
| 7 Grip | |
| 8 Drive switch forwards/backwards | |
| 9 Belly Button/Emergency brake | |
| 10 Lock on/off | |

Steering handles

The steering handle (1.6) with bar is a fixed part of the Multi-Mover 3XL 30TO, moving to the left

means driving to the left, and vice versa.

Safety switch 2.9

When pressing the safety switch (risk of getting jammed), the Multi-Mover 3XL 30TO will stop immediately.

In order to start again, the drive switch must first be placed in the neutral position.

Coupling point upward 2.16 , # coupling point downward

Optionally, the coupling point can be moved upward/downward with a Hydraulic lifting device. This serves, for instance, to make it easier to move a tandem XXL trailer.

Signal switch (2.13)

Horn. 85dB

Drive switches (2.8), left and right from the centre

By rotating the drive switch (2.8) to the front with your thumb, the driving direction will first be switched on and then, when rotated further, the Multi-Mover 3XL 30TO will start to drive. The central position is the neutral position.

By rotating it downwards, the Multi-Mover 3XL 30TO will reverse.

Caution! Only switch to forward or reverse if the Multi-Mover 3XL 30TO is standing still.

Ignition lock 2.10

The ignition lock is used to switch off the batteries, **always switch off the battery in case of maintenance to the Multi-Mover 3XL 30TO.**

Inching (Fig 3)

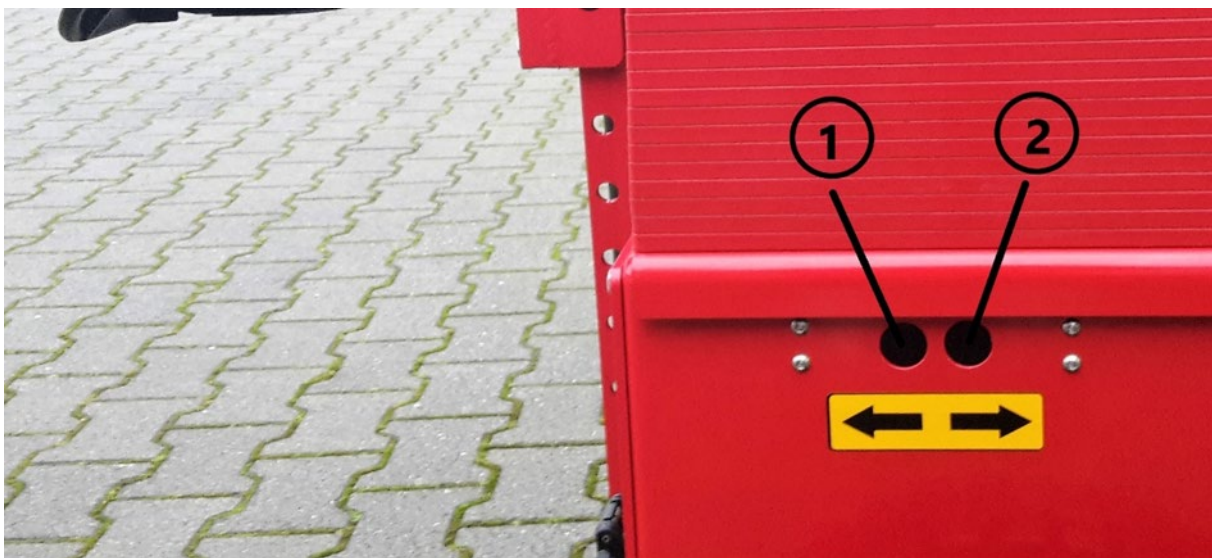

At the front left there are 2 buttons for moving slowly forwards (Fig 3, 1) and backwards (Fig 3, 2). Press the button 1 time to unlock, pressing the button the second time you can drive a couple of inches forward or backward. The maximum speed can be set using the potentiometers (Fig 2, 7 and 8) on the tiller head. The maximum distance you can travel in this way is approx. 1 meter.

5.4 Batteries (1.9)

The batteries are filled with lead acid and sealed. They are fully sealed and maintenance free. It is not possible to refill.

Battery charger connection

The connection plug for the battery charger is located on the right side, in a recess of the encasing. On the dashboard of the Multi-Mover 3XL 30TO, **the battery indicator (2.4)** is placed.

Red = charge immediately

Yellow = charge soon

Green = Battery is full

For a longer life span, it is better not to allow the battery to get completely empty. It is also not good to continue charging a battery that is almost full.

If the Multi-Mover 3XL 30TO is out of operation (for a longer period), we recommend keeping the battery charger connected, it will automatically keep the battery in a charged condition.

Charging location

The charging location must be well ventilated, because very explosive gases (detonating gas) are continuously released during charging.

Avoid open fire or sparks at the charging location while charging. During charging, an explosive gas may be released.

The battery charger operates fully automatically, i.e. the charger is equipped with an electronic system that will check the charging status and act accordingly.

Check whether the supply voltage to the battery charger corresponds with the voltage stated on the battery charger.

Some instructions for battery use and maintenance.

Charging

- 1 Insert the plug of the battery charger into the connection on the encasing and connect the battery charger to the mains.
- 2 In the second phase, the automatic battery charger will charge all elements at maximum voltage in the final phase the battery charger will stop.
The battery charger will switch off automatically.

Premature wear of the battery

If the batteries are used incorrectly, it is possible that they wear quickly. Premature wear is not an error in production and is therefore not within the scope of the warranty arrangement.

Therefore, we would like to draw your attention to the following:

Excessive load of the battery

If the batteries are loaded excessively, this will strongly reduce the life span. This means that you will have to adapt the load.

Discharging too deeply

We recommend not to discharge the batteries completely. If this happens often, it will also result in premature wear. Keep a close eye on the battery indicator, connect the battery charger in time.

If the BDI (Battery discharge Index) is below 30% maximum speed is reduced to 50%, this to prevent damage to the batteries. Make sure you charge right away.

Adapted charger.

The batteries should be charged with a correct charger and during a specific period. If the charging current is too low, or if the duration of the charging process is too short, the batteries will not be fully charged and the capacity of the batteries will be too low for your application, resulting in premature wear. If the charging current is too high, or if the duration of the charging process is too long, the battery can be overcharged. As a result, the plates of your battery will overheat and may become damaged.

Intermediate charging

If, for example, the batteries are empty for only 20% and are reconnected to the charger, the batteries will not get the time to relax. The temperature of the batteries will increase, resulting in premature wear. Also, the voltage of the battery will become higher than the actual energy condition, which means that the discharge limiter will no longer work correctly.

Ambient temperature

The temperature of the battery may not get too high, as the acid will become more aggressive. Here, we are thinking of greenhouses and other heated spaces.

Frequent use

If the Multi-Mover 3XL 30TO is used more than 8 hours a day, the batteries will also wear more quickly. When selecting batteries, it is important to take into account the Multi-Mover XXL's frequency of use. If the batteries are used very frequently and intensively, it will be necessary to select the full traction battery set instead of the standard batteries.

Sulphating

A battery will slowly discharge as a result of automatic discharge. If a battery remains in a discharged condition, it will start to sulphate and become damaged beyond repair. We therefore recommend recharging the stored Multi-Mover 3XL 30TO every 2 months.

It is also possible, that there are still standby consumers in a switched off Multi-Mover 3XL 30TO (key ignition etc.), which will mean that the batteries will discharge more quickly.

In that case, regular recharging of the batteries is recommended.

Immediate recharging of an empty battery, significantly promotes a longer life span. Further discharging than 20% has a negative effect on the life span.

The gases that can be released while charging the battery are highly explosive (detonating gas).

Therefore, avoid fire and sparks near the charging location.

Charging may only take place in a well ventilated room.

Regularly check whether the battery charger stops automatically when the battery is full.

Never interrupt the charging process, make sure it is fully completed.

While charging the battery, **never** perform repair, cleaning or other work to the Multi-Mover 3XL 30TO.

Prior to disassembling the batteries, switch off all power consumers, because of the generation of sparks.

When disassembling the batteries, first disconnect the mass cable (-)

When assembling, connect the mass cable as last.

Caution! Always plus (+ = red) to plus and minus (- = black) to minus

Battery fluid is a corrosive acid, avoid contact with clothing, skin and eyes.

Immediately wash off possible splashes on clothes or skin with water and soap, then rinse off with plenty of water. Possible splashes of acid in the eyes, rinse with clean water for at least 5 minutes and immediately consult a doctor.

When the battery is replaced, the old battery should be returned to your dealer or handed in at a legally recognized collection point for batteries.

5.5 Coupling trailer(s)

The Multi-Mover 3XL 30TO is made with a standard tow hitch with tow pin or a ball coupling point in the middle of the Multi-Mover 3XL 30TO, to which the pole of a trailer can be coupled.

#Maximum slope angle, with / without load 4 / 20 %

Slowly reverse the Multi-Mover 3XL 30TO to the pole of the trailer and place the tow eye or coupling of the pole between the tow eyes or coupling point of the Multi-Mover 3XL 30TO and insert the tow pin. Using the inching buttons (2.2). Then secure the tow pin with a spring clip.

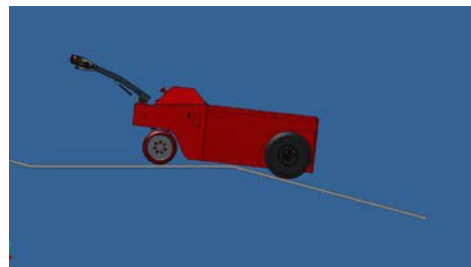
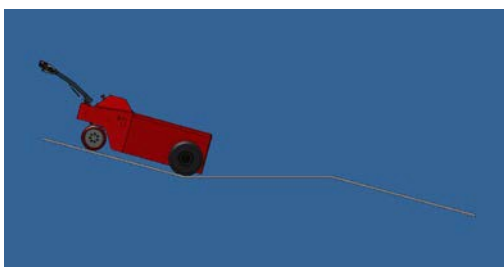

11 degrees maximum

Only use the Multi-Mover 3XL 30TO if you have thoroughly studied the previous pages and you have no more questions.

6 MAINTENANCE

When performing maintenance, you should always observe the safety regulations, (chapter 3).

During maintenance, always switch off the Multi-Mover 3XL 30TO and remove the ignition key from the ignition lock

In case of doubt, consult the user manual.

6.1 Inspection

The operator should perform the following inspections regularly, without trailer;

- it must be possible to rotate the steering handle (swivel wheel) smoothly to the left and right, without jolts
- keep an eye on the wear of driven tyres, if the wheels slip in case of sudden brakes, they will have to be replaced
- when accelerating quietly, it must be possible to reach the maximum speed

If one of the above tests is not satisfactory, you must immediately report this to person who is directly responsible for the maintenance of the Multi-Mover 3XL 30TO.

Remove weight package



This model has 2 counterweight layers of approx. 600 kg each. You can lift these from the machine with 4 lifting eyes supplied. Screw these lifting eyes into the holes provided. (see photo). This way you can only lift the weight package and not the entire machine.

6.2 Lubrication and maintenance diagram

d = daily w = weekly m = monthly a = annually m = maintenance r = replacement

= only by qualified, trained, specialists

	m / r	d / w / m/ a
1 inspection / cleaning bottom side Multi-Mover 3XL 30TO	m	d
2 inspection battery charge, depending on intensity of use	m	d
3 inspection wear drive wheels	m	w
4 lubricating nipples on bearings drive and steering wheels	v#	a

6.3 Cleaning

When used inside and outside, the bottom will become dirty with particles from the surroundings. It is necessary to remove this dirt regularly, as contamination could

hinder the operation of the drive.

Do not use a high-pressure cleaner or a hard water jet for cleaning, as the electric and electronic system is not water-tight and could be damaged.

6.4 Taking out of operation

If the Multi-Mover 3XL 30TO is not used for a certain period, you will have to;

- connect the battery charger
- place the Multi-Mover 3XL 30TO on blocks, so that the tyres do not touch the ground

Have maintenance and repairs performed by persons authorized by Multi-Mover Europe BV. In case of doubt, always consult your supplier.

For the above-mentioned maintenance instructions, we assumed normal use.

In case of intensive use, or use under extreme conditions, maintenance will have to be performed with shorter intervals.

6.5 Annual maintenance. ***

See 6.2 +

Check whether all bolts are still tight and check the rotation/hinge points and guides for wear and play, replace or overhaul if necessary.

Check the carbon brushes for wear and have them replaced if necessary.

***** = only by qualified, trained specialists**

7 ENVIRONMENT

7.1 General

Residues of lubrication oil, oil-stained cloths, batteries and possible cleaning agents must be disposed of separately as chemical waste.

7.2 Consequences for the environment

Life span

The expected life span of the Multi-Mover 3XL 30TO depend on maintenance, operating hours and ambient conditions (dust, contamination, humidity etc.).

Good maintenance will be beneficial to the life span.

Disposal

Preferably, you should have the disposal and processing performed by a recognized dismantlement or demolition contractor who has the necessary permits.

Appoint a competent responsible person to supervise its execution.

Sort disassembled materials according to material characteristics and contamination.
Separate all materials that fall under the category of chemical waste, such as oil, lubricants, switching material, batteries and certain electric components. Dispose them as chemical waste.
Offer residual materials to recognized waste processing companies who have the required permits.

8 FAILURES

When removing a failure, ALWAYS switch off the Multi-Mover 3XL 30TO and remove the ignition key. If a defect is established at the Multi-Mover 3XL 30TO, do not use it until the repair has been completed.

Failure	Solution
A The Multi-Mover 3XL 30TO does not drive.	
1 Emergency stop has been pressed	1 Pull out
2 Battery empty	2 Charge battery
3 Battery clamps make poor contact	3 Clean, attach again
4 Direction switch defective	4 Replace switch
5 Other causes.	5 Consult your dealer
B The Multi-Mover 3XL 30TO functions occasionally.	
1 Loose wiring	1 Check wiring
2 Dirty or worn collector motor	2 Clean, or have it overhauled, or replace it
3 Relay does not come "in" properly due to contamination or defect	3 Clean or replace
C Speed cannot be controlled (properly), or it drives at high speed immediately.	
1 Speed controller defective	1 Replace
2 Relay defective	2 Replace

In case of a failure not mentioned in the list above, please contact your dealer.

Note: In the warranty period, it is absolutely prohibited to perform repairs, changes and modifications or anything like that to the Multi-Mover 3XL 30TO, the warranty will become invalid automatically.

9 PARTS (Ex view on request)

001 Battery (state amperage)	009 Castor wheels
002 Drive motor	010 Axle
004 Relay	011 Battery plug
005 Speed switch	012 Female plug for battery plug
006 Ignition lock	013 Fuses, set
007 Reverse switch forward - reverse	014 Main fuse
008 Drive wheel	020 Symbol stickers

10

EC DECLARATION OF CONFORMITY **IIA**
(according to Appendix II A of the Machinery Directive)

We, Multi-Mover Europe BV,
Boomsestraat 38, 6613 AH Balgoij, Netherlands

declare at our own full responsibility, that the Multi-Mover ***, with serial number 2020***

to which this declaration applies, is in conformity with the provisions of the following directive(s):

Applied directive :

2006/42/EC

and is in conformity with the following standard(s) or other standardizing document(s):

EN-ISO 12100	Safety of machinery -- General principles for design -- Risk assessment and risk reduction.
EN-ISO 14121-2	Safety of machinery -- Risk assessment -- Part 2: Practical guidance and examples of methods.
EN-ISO 13857	Safety of machinery -- Safety distances to prevent hazard zones being reached by upper and lower limbs.
EN-953	Safety of machinery - Guards - General requirements for the design and construction of fixed and movable guards
EN-82079-1	Preparation of instructions for use -- Structuring, content and presentation -- Part 1: General principles and detailed requirements
EN 60204-1	Safety of machinery - Electrical equipment of machines - Part 1: General requirements.
EN-IEC 60439-1	Low-voltage switchgear and controlgear assemblies – Part 1: Type-tested and partially type-tested assemblies.
EN ISO 3864-2	Graphical symbols -- Safety colours and safety signs -- Part 2: Design principles for product safety labels

Authorized compiler of the technical file :

Netherlands, Balgoij, 1.1.2021
(Country, city and date of issue)

JJ Offerman
(Name and signature or equivalent authentication by authorized person)